

LQW18AN30NG00#

“#” indicates a package specification code.

Size Code 1608 (0603) in mm (in inch), Wound Type



< List of part numbers with package codes >

LQW18AN30NG00B LQW18AN30NG00D LQW18AN30NG00J

Appearance & Shape

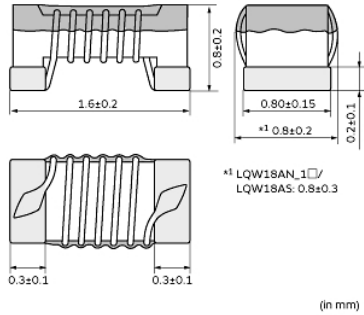
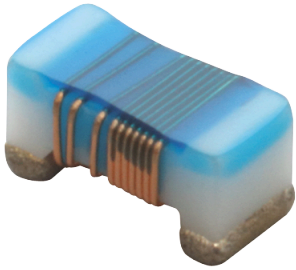

References

| Packaging | Specifications | Standard Packing Quantity |
|-----------|------------------|---------------------------|
| B | Bulk(Bag) | 500 |
| D | 180mm Paper Tape | 4000 |
| J | 330mm Paper Tape | 10000 |

| Mass (typ.) | |
|-------------|--------|
| 1 piece | 0.003g |

Attention

- 1.This datasheet is downloaded from the website of Murata Manufacturing Co., Ltd. Therefore, it's specifications are subject to change or our products in it may be discontinued without advance notice. Please check with our sales representatives or product engineers before ordering.
- 2.This datasheet has only typical specifications because there is no space for detailed specifications. Therefore, please review our product specifications or consult the approval sheet for product specifications before ordering.

LQW18AN30NG00#

“#” indicates a package specification code.



Specifications

| | |
|--|----------------|
| L size | 1.6±0.2mm |
| W size | 0.8±0.2mm |
| T size | 0.8±0.2mm |
| Size code inch (mm) | 0603 (1608) |
| Inductance | 30nH±2% |
| Inductance Test Frequency | 100MHz |
| Rated current (Itemp) (Based on Temperature rise) | 420mA |
| Max. of DC resistance | 0.23Ω |
| Q(min.) | 40 |
| Q Test Frequency | 250MHz |
| Self resonance frequency (min.) | 3300MHz |
| Operating Temperature Range(Self-temperature rise is not included) | -55°C to 125°C |
| Series | LQW18AN_00 |

Attention

1.This datasheet is downloaded from the website of Murata Manufacturing Co., Ltd. Therefore, it's specifications are subject to change or our products in it may be discontinued without advance notice. Please check with our sales representatives or product engineers before ordering.

2.This datasheet has only typical specifications because there is no space for detailed specifications.

Therefore, please review our product specifications or consult the approval sheet for product specifications before ordering.

LQW18AN30NG00#

“#” indicates a package specification code.



Characteristic Data

The charts below may show another part number which shares its characteristics.

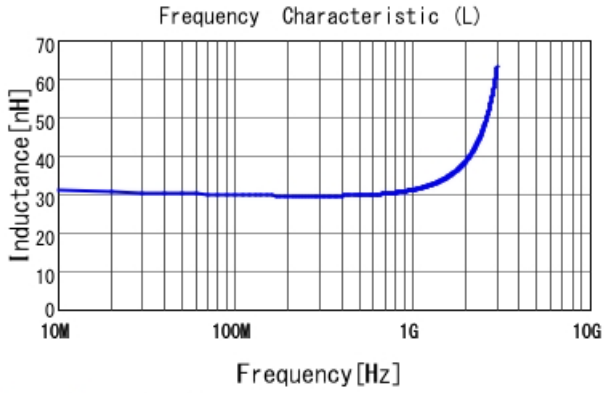

LQW18AN30NG00 L

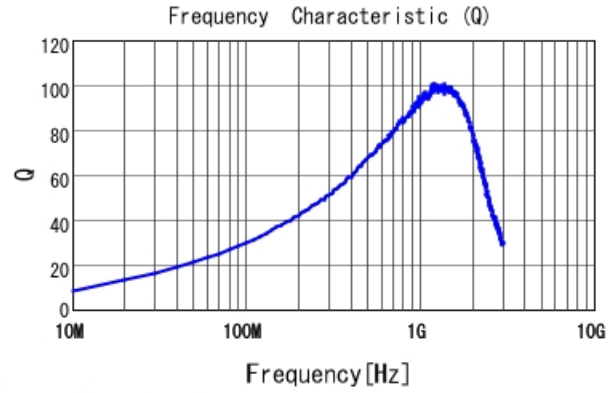

LQW18AN30NG00 Q

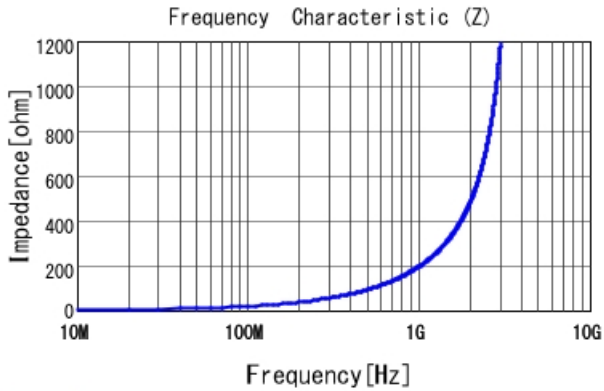

LQW18AN30NG00 |Z|

Attention

- 1.This datasheet is downloaded from the website of Murata Manufacturing Co., Ltd. Therefore, it's specifications are subject to change or our products in it may be discontinued without advance notice. Please check with our sales representatives or product engineers before ordering.
- 2.This datasheet has only typical specifications because there is no space for detailed specifications. Therefore, please review our product specifications or consult the approval sheet for product specifications before ordering.