

### KPX-1200A series Magnetic Buzzer

#### DIMENSIONS

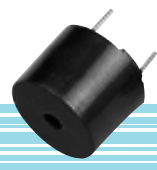

color Black  
PBT Housing Material  
Pin Terminal

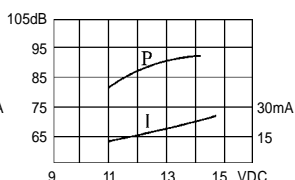
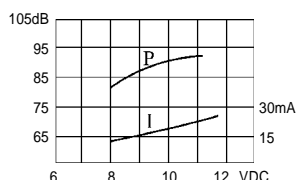
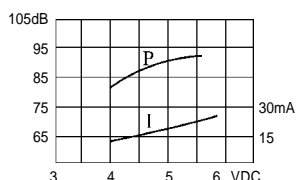
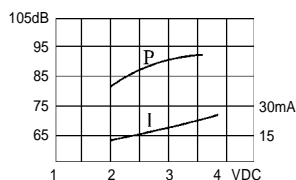
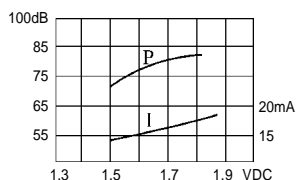
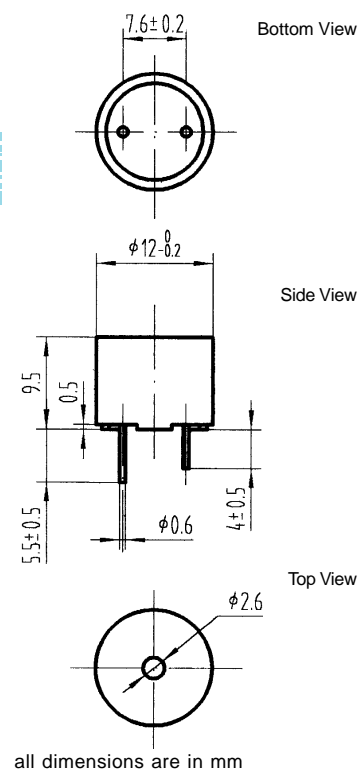

Model No	KPX-1201A	KPX-1203A	KPX-1205A	KPX-1209A	KPX-1212A
Rated Voltage	1.5VDC	3VDC	5VDC	9VDC	12VDC
Operating Voltage	1~2VDC	2~5VDC	4~8VDC	7~12VDC	8~15VDC
Max. Rated Current	20mA/1.5VDC	30mA/3VDC	30mA/5VDC	30mA/12VDC	30mA/12VDC
Min. Sound Pressure Level	75dB/10cm	80dB/10cm	85dB/10cm	85dB/10cm	85dB/10cm
Resonant Frequency	2300 <sub>i</sub> Å300Hz	2300 <sub>i</sub> Å300Hz	2300 <sub>i</sub> Å300Hz	2300 <sub>i</sub> Å300Hz	2300 <sub>i</sub> Å300Hz
Operating Temperature	-20~+70jæ	-20~+70jæ	-20~+70jæ	-20~+70jæ	-20~+70jæ
Weight	2g	2g	2g	2g	2g

\* Value applying at rated voltage

### KPX-1203B KPX-1205B KPX-1212B series Magnetic Buzzer

#### DIMENSIONS

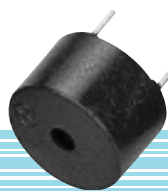
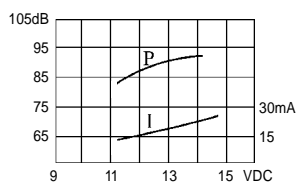
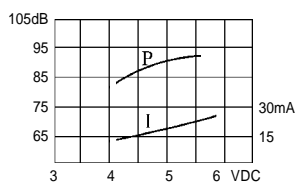
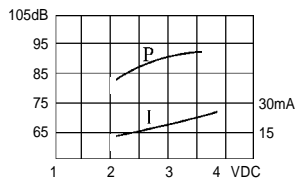

color Black  
PBT Housing Material  
Pin Terminal

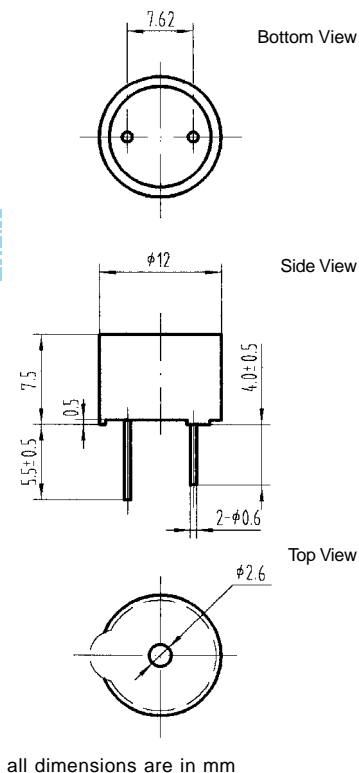

Model No	KPX-1203B	KPX-1205B	KPX-1212B
Rated Voltage	3VDC	5VDC	12VDC
Operating Voltage	2~5VDC	4~8VDC	8~15VDC
Max. Rated Current	30mA/3VDC	30mA/5VDC	30mA/12VDC
Min. Sound Pressure Level	85dB/10cm	85dB/10cm	85dB/10cm
Resonant Frequency	3100 <sub>i</sub> Å500Hz	3100 <sub>i</sub> Å500Hz	3100 <sub>i</sub> Å500Hz
Operating Temperature	-20~+70jæ	-20~+70jæ	-20~+70jæ
Weight	2g	2g	2g

\* Value applying at rated voltage

The information contained herein is believed to be correct, but no guarantee for accuracy, completeness DSW Electronics Ltd. reserves the right to make changes without notification.