



GaAs MMIC VOLTAGE-VARIABLE ATTENUATOR, 0.5 - 6.0 GHz

Typical Applications

The HMC973LP3E is ideal for:

- Point-to-Point Radio
- Cellular/3G & WiMAX/4G Infrastructure
- Test Instrumentation
- Microwave Sensors
- Military, ECM & Radar

Features

- Excellent Linearity: +35 dBm Input IP3
- Wide Attenuation Range: 26 dB
- Single Positive Voltage Control: 0 to +5V
- Absorptive Topology
- 16 Lead 3x3mm SMT Package: 9mm²

Functional Diagram

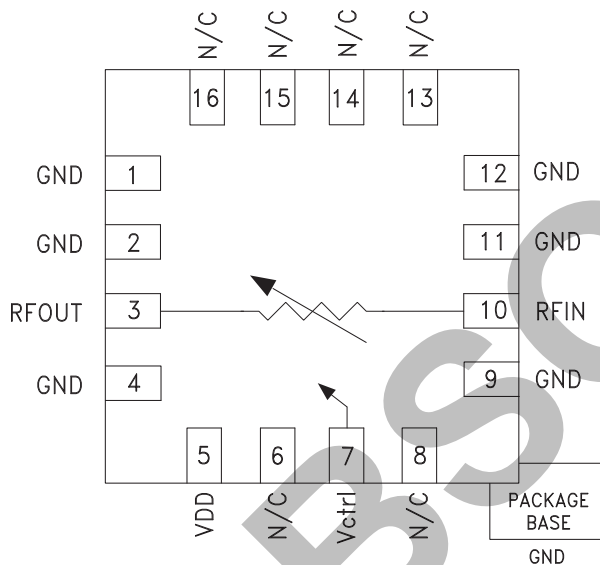

General Description

The HMC973LP3E is an absorptive Voltage Variable Attenuator (VVA) which operates from 0.5 to 6 GHz and is ideal in designs where an analog DC control signal must be used to control RF signal levels over a 26 dB amplitude range. It features a shunt-type attenuator controlled by an analog voltage, Vctrl. Unlike other GaAs FET based VVA's the HMC973LP3E exhibits excellent linearity of +35 dBm input IP3, throughout its control range. The HMC973LP3E is an unidirectional device with optimum linearity performance achieved when the RF input signal is applied to the RFIN package lead. The HMC973LP3E is housed in a RoHS compliant 3x3 mm QFN leadless package.

Electrical Specifications, $T_A = +25^\circ\text{C}$, 50 Ohm system, Vdd = +5V

| Parameter | Frequency | Min. | Typ. | Max. | Units |
|--|---------------|------|------|------|---------------|
| Insertion Loss | 0.5 - 4.0 GHz | | 3.5 | 5 | dB |
| | 4.0 - 6.0 GHz | | 5.5 | 8 | dB |
| Attenuation Range | 0.5 - 3.0 GHz | | 26 | | dB |
| | 3.0 - 6.0 GHz | | 28 | | dB |
| Input Return Loss | 0.5 - 6.0 GHz | | 12 | | dB |
| Output Return Loss | 0.5 - 6.0 GHz | | 10 | | dB |
| Input Power for 1 dB Compression (any attenuation) | 0.5 - 6.0 GHz | | 30 | | dBm |
| Input Third Order Intercept (Two-tone Input Power = +5 dBm Each Tone) | 0.5 - 6.0 GHz | | 35 | | dBm |
| Supply Current (Idd) | 0.5 - 6.0 GHz | | 200 | 300 | μA |



GaAs MMIC VOLTAGE-VARIABLE ATTENUATOR, 0.5 - 6.0 GHz

Insertion Loss vs. Frequency Over Temperature

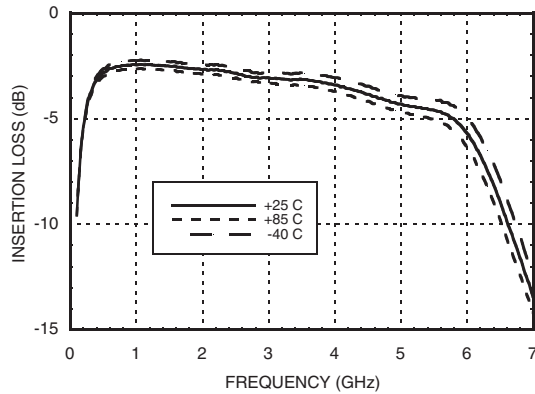

Attenuation vs. Frequency Over Vctrl

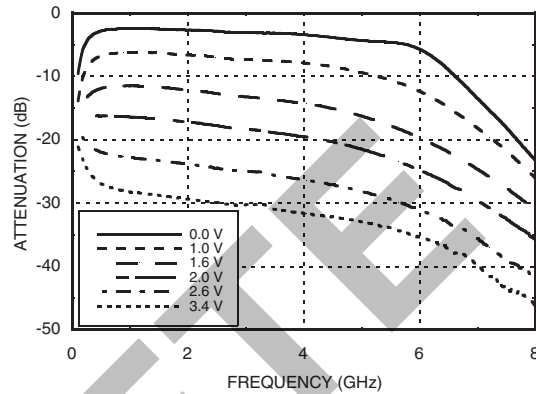

Attenuation vs. Vctrl Over Temperature @ 0.5 GHz

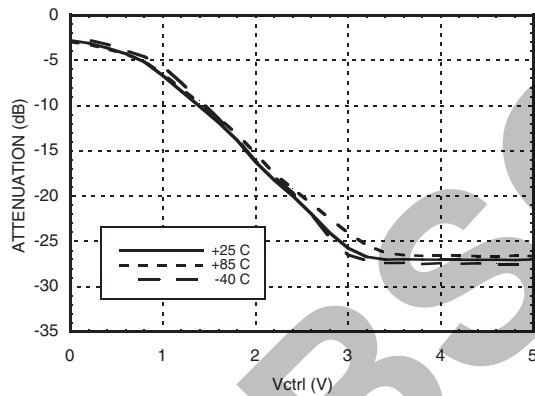

Attenuation vs. Vctrl Over Temperature @ 2 GHz

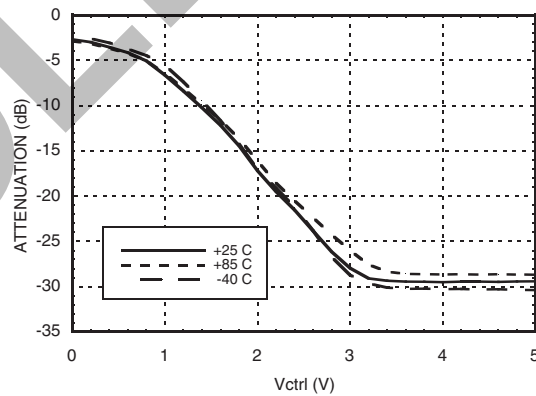

Attenuation vs. Vctrl Over Temperature @ 4 GHz

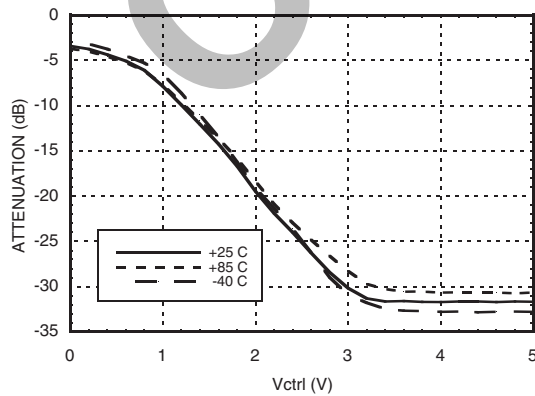

Attenuation vs. Vctrl Over Temperature @ 6 GHz

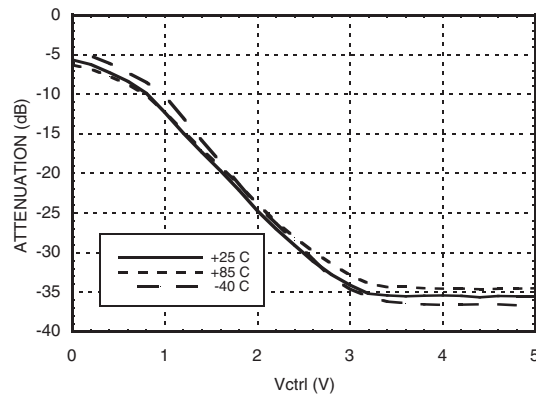

Information furnished by Analog Devices is believed to be accurate and reliable. However, no responsibility is assumed by Analog Devices for its use, nor for any infringements of patents or other rights of third parties that may result from its use. Specifications subject to change without notice. No license is granted by implication or otherwise under any patent or patent rights of Analog Devices. Trademarks and registered trademarks are the property of their respective owners.

For price, delivery, and to place orders: Analog Devices, Inc., One Technology Way, P.O. Box 9106, Norwood, MA 02062-9106 Phone: 781-329-4700 • Order online at www.analog.com Application Support: Phone: 1-800-ANALOG-D



GaAs MMIC VOLTAGE-VARIABLE ATTENUATOR, 0.5 - 6.0 GHz

8

ATTENUATORS - ANALOG - SMT

Input Return Loss Over Temperature (Vctrl = 0)

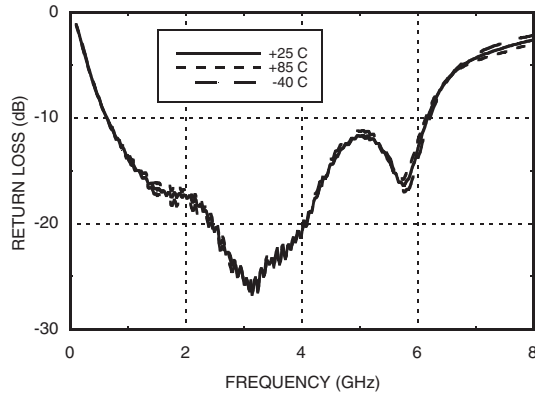

Input Return Loss Over Vctrl

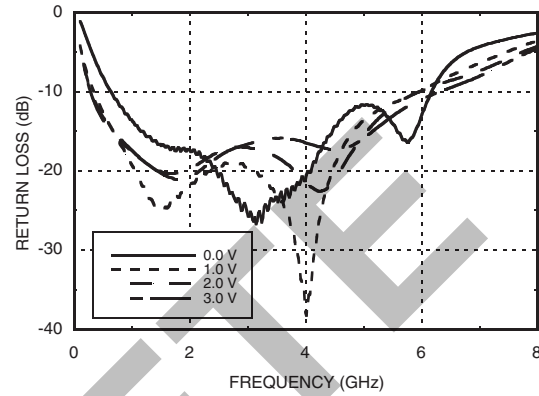

Output Return Loss Over Temperature (Vctrl = 0)

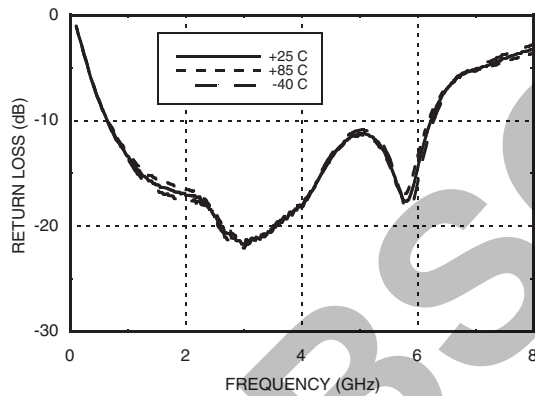

Output Return Loss Over Vctrl

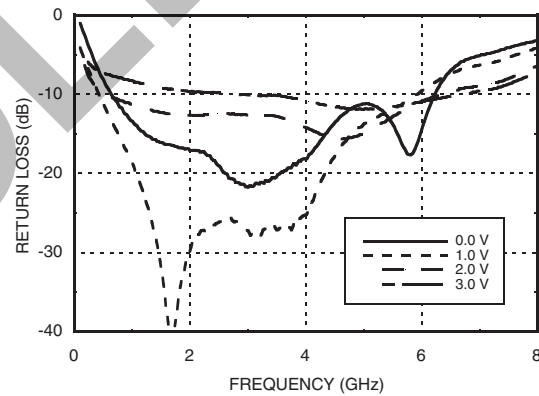

Input IP3 Over Vctrl

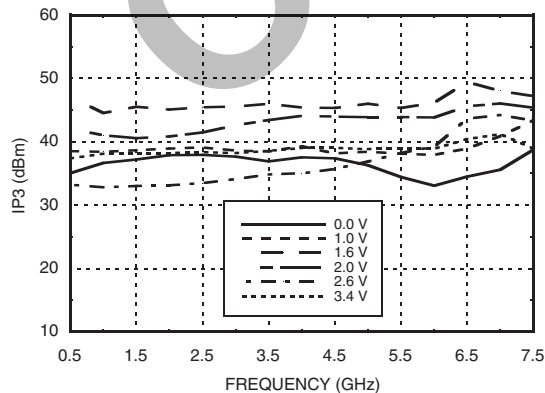

Input IP3 Over Temperature (Vctrl = 0V)

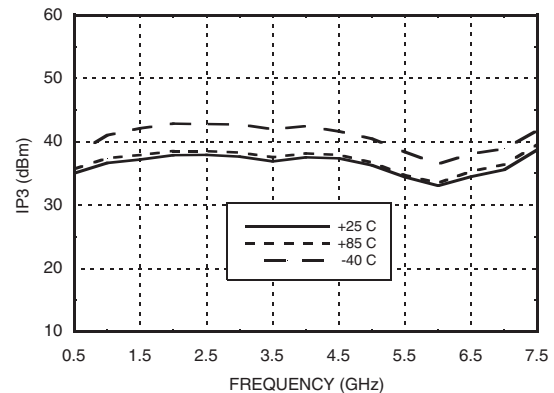

Information furnished by Analog Devices is believed to be accurate and reliable. However, no responsibility is assumed by Analog Devices for its use, nor for any infringements of patents or other rights of third parties that may result from its use. Specifications subject to change without notice. No license is granted by implication or otherwise under any patent or patent rights of Analog Devices. Trademarks and registered trademarks are the property of their respective owners.

For price, delivery, and to place orders: Analog Devices, Inc., One Technology Way, P.O. Box 9106, Norwood, MA 02062-9106 Phone: 781-329-4700 • Order online at www.analog.com Application Support: Phone: 1-800-ANALOG-D

GaAs MMIC VOLTAGE-VARIABLE ATTENUATOR, 0.5 - 6.0 GHz



Absolute Maximum Ratings

| | |
|---|----------------|
| RF Input Power | +29 dBm |
| Vdd | 5.5V |
| Control Voltage Range | -0.5 to 5.5V |
| Channel Temperature | 150 °C |
| Continuous P _{diss} (T = 85 °C) | 0.8W |
| Thermal Resistance (Channel to ground paddle) | 80 °C/W |
| Storage Temperature | -65 to +150 °C |
| Operating Temperature | -40 to +85 °C |
| ESD Sensitivity (HBM) | Class 1A |

Voltages & Currents

| | |
|-------|-------------------|
| Vdd | 5V @ 200 μA |
| Vctrl | 0 to +5V @ 100 μA |



ELECTROSTATIC SENSITIVE DEVICE
OBSERVE HANDLING PRECAUTIONS

Outline Drawing

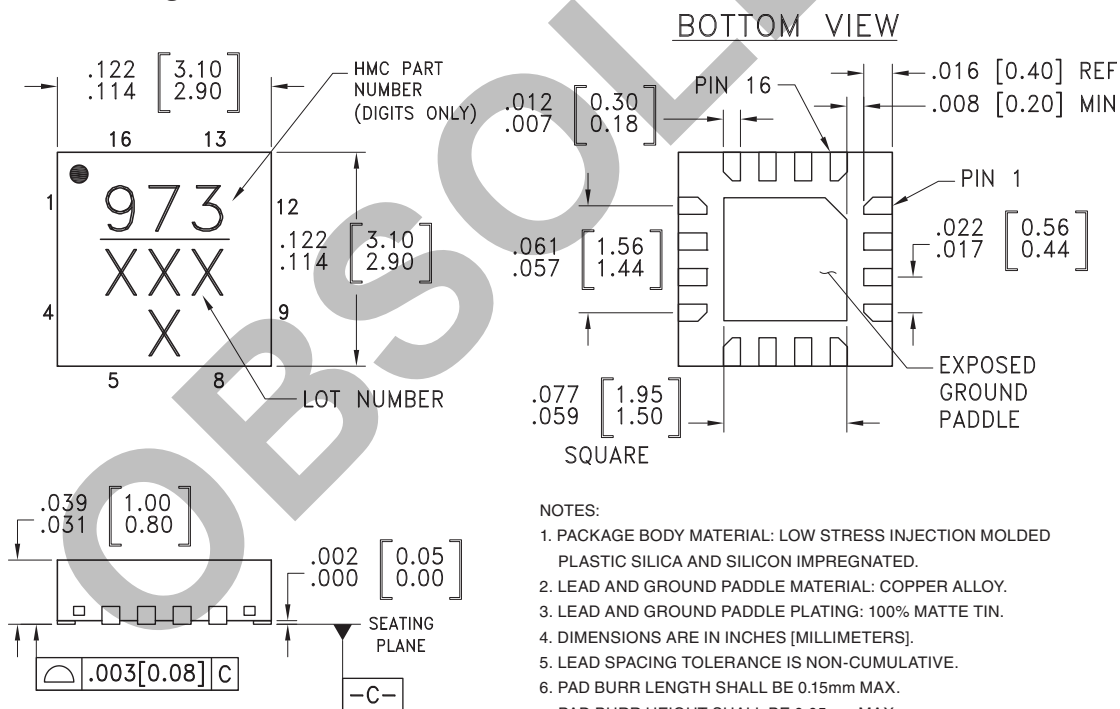

NOTES:

1. PACKAGE BODY MATERIAL: LOW STRESS INJECTION MOLDED PLASTIC SILICA AND SILICON IMPREGNATED.
2. LEAD AND GROUND PADDLE MATERIAL: COPPER ALLOY.
3. LEAD AND GROUND PADDLE PLATING: 100% MATTE TIN.
4. DIMENSIONS ARE IN INCHES [MILLIMETERS].
5. LEAD SPACING TOLERANCE IS NON-CUMULATIVE.
6. PAD BURR LENGTH SHALL BE 0.15mm MAX.
PAD BURR HEIGHT SHALL BE 0.05mm MAX.
7. PACKAGE WARP SHALL NOT EXCEED 0.05mm
8. ALL GROUND LEADS AND GROUND PADDLE MUST BE SOLDERED TO PCB RF GROUND.
9. REFER TO HITTITE APPLICATION NOTE FOR SUGGESTED PCB LAND PATTERN.

Package Information

| Part Number | Package Body Material | Lead Finish | MSL Rating | Package Marking ^[1] |
|-------------|--|---------------|---------------------|--------------------------------|
| HMC973LP3E | RoHS-compliant Low Stress Injection Molded Plastic | 100% matte Sn | MSL1 ^[2] | H973 XXXX |

[1] 4-Digit lot number XXXX

[2] Max peak reflow temperature of 260 °C

GaAs MMIC VOLTAGE-VARIABLE ATTENUATOR, 0.5 - 6.0 GHz



Pin Descriptions

| Pin Number | Function | Description | Interface Schematic |
|-------------------------------------|----------|---|---------------------|
| 1, 2, 4, 9, 11, 12 Ground Paddle | GND | These pins and the exposed ground paddle must be connected to RF/DC ground. | |
| 3 | RFOUT | This pin is DC coupled and matched to 50 Ohms. A blocking capacitor is required if RF line potential is not equal to 0V. | |
| 5 | Vdd | Supply Voltage | |
| 6, 8, 13 - 16 | N/C | The pins are not connected internally; however, all data shown herein was measured with these pins connected to RF/DC ground externally. | |
| 7 | Vctrl | Control Voltage | |
| 10 | RFIN | This pin is DC coupled and matched to 50 Ohms. A blocking capacitor is required if RF line potential is not equal to 0V. The HMC973LP3E is a unidirectional device with optimum linearity performance achieved with RF input signal applied to RFIN package lead. | |

Application Circuit

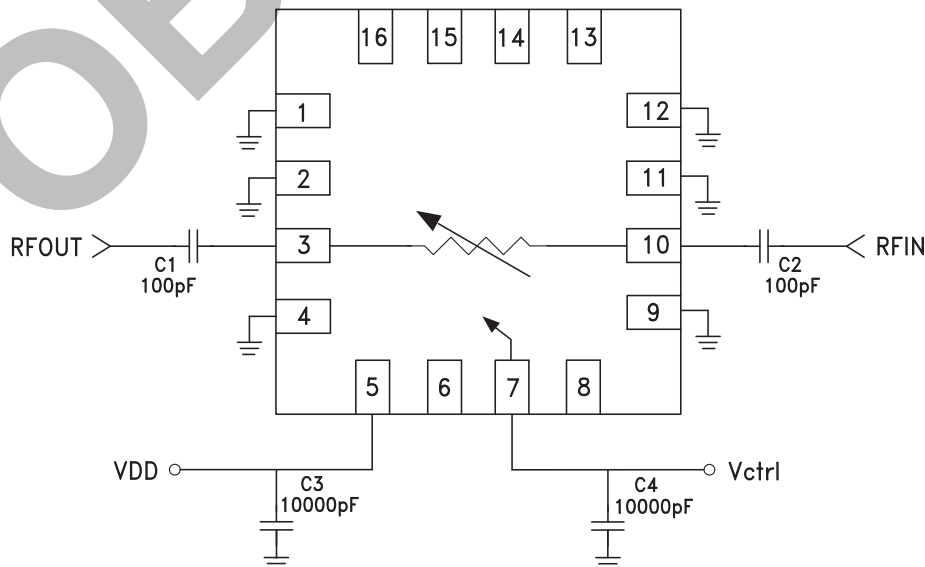

Information furnished by Analog Devices is believed to be accurate and reliable. However, no responsibility is assumed by Analog Devices for its use, nor for any infringements of patents or other rights of third parties that may result from its use. Specifications subject to change without notice. No license is granted by implication or otherwise under any patent or patent rights of Analog Devices. Trademarks and registered trademarks are the property of their respective owners.

For price, delivery, and to place orders: Analog Devices, Inc., One Technology Way, P.O. Box 9106, Norwood, MA 02062-9106 Phone: 781-329-4700 • Order online at www.analog.com Application Support: Phone: 1-800-ANALOG-D



Evaluation PCB

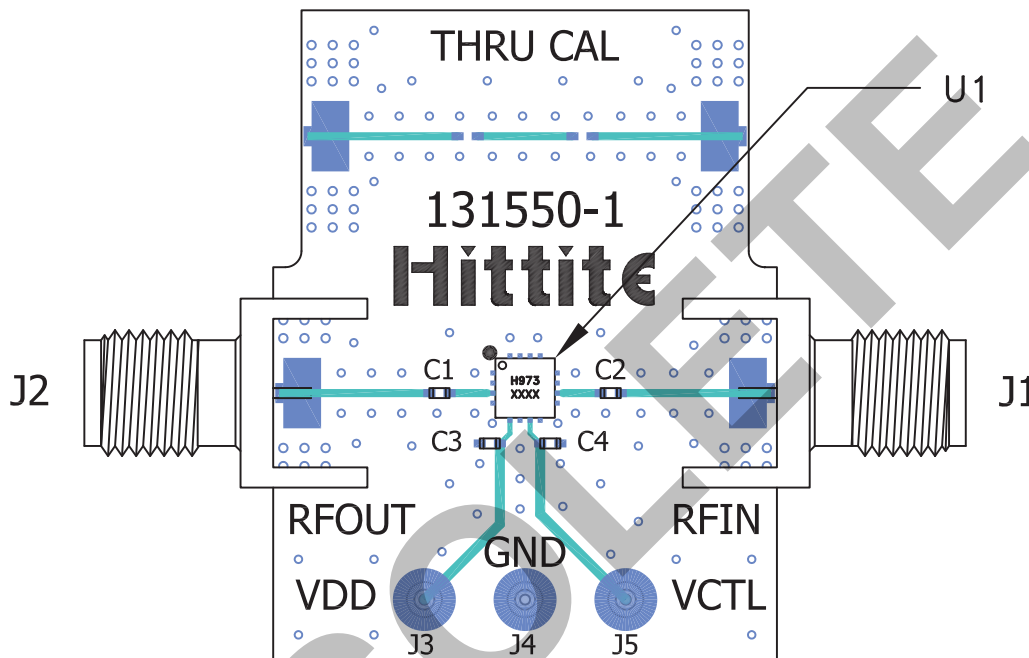

List of Materials for Evaluation PCB 131552 [1]

| Item | Description |
|---------|--|
| J1, J2 | PCB Mount SMA RF Connector |
| J3 - J5 | DC Pin |
| C1, C2 | 100 pF Capacitor, 0402 Pkg. |
| C3, C4 | 10000 pF Capacitor, 0402 Pkg. |
| U1 | HMC973LP3E Voltage Variable Attenuator |
| PCB [2] | 131550 Evaluation PCB |

[1] Reference this number when ordering complete evaluation PCB

[2] Circuit Board Material: Arlon 25FR or Rogers 4350

The circuit board used in the application should use RF circuit design techniques. Signal lines should have 50 Ohm impedance while the package ground leads and exposed paddle should be connected directly to the ground plane similar to that shown. A sufficient number of via holes should be used to connect the top and bottom ground planes. The evaluation circuit board shown is available from Hittite upon request.