

### Device Features

- OIP3 = 32.7dBm @ 1250 MHz
- Gain = 17.4 dB @ 1250 MHz
- Output P1 = 17.6 dBm @1250 MHz
- Patented temperature compensation
- Lead-free/RoHS-compliant SOT-89 SMT package

### Product Description

BeRex's BG17C is a high performance InGaP/GaAs HBT MMIC amplifier is internally matched to 75 Ohms and uses a patented **temperature compensation** circuit to provide stable current over the operating temperature range without the need for external components. The BG17C is designed for high linearity gain block applications that require high gain and low power consumption at 5V. It is packaged in a RoHS-compliant with SOT-89 surface mount package and design in set-top infrastructure projects for 75ohm CATV and satellite applications.

### Applications

- Set-Top Box
- Satellite & Drop Amplifier
- FTTH Receiver / Optical Transmitter
- RFoG / MOCA

### Applications Circuit

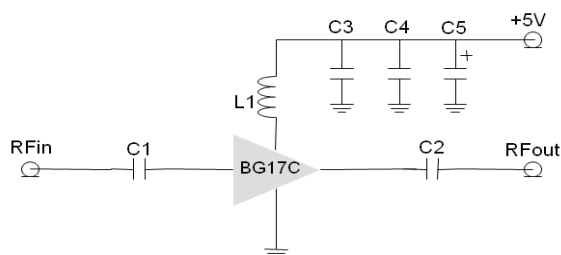

Figure 1 Applications Circuit

### Package Type



SOT-89 SMT Package  
Figure 2 Package Type

### Typical Performance<sup>1</sup>

Parameter	Value						Unit
	100 <sup>2</sup>	300 <sup>2</sup>	800 <sup>2</sup>	950	1550	2150	
Frequency	100 <sup>2</sup>	300 <sup>2</sup>	800 <sup>2</sup>	950	1550	2150	MHz
Gain	19.4	18.1	17.4	17.9	17.0	15.6	dB
S11	-10.6	-12.4	-17.6	-10.2	-16.6	-18.6	dB
S22	-16.6	-14.8	-12.5	-12.4	-13.1	-12.5	dB
OIP3 <sup>3</sup>	33.2	33.7	32.0	31.7	32.4	30.6	dBm
P1dB	17.7	17.8	17.5	16.7	18.0	17.1	dBm
NF	4.7	4.8	4.9	5.0	5.1	5.1	dB

<sup>1</sup> Device performance \_ measured on a BeRex evaluation board at 25°C, 75 Ω system.

<sup>2</sup> 45 to 800MHz. Value were measured with IF Band tuned.

<sup>3</sup> OIP3 \_ measured with two tones at an output of 2dBm per tone separated by 1 MHz.

Parameter	Min.	Typical	Max.	Unit
Bandwidth	45		2200	MHz
I <sub>c</sub> @ (V <sub>c</sub> = 5V)	45	55	65	mA
V <sub>c</sub>		5.0		V
dG/dT		-0.004		dB/°C
R <sub>TH</sub>		50		°C/W

### Absolute Maximum Ratings

Parameter	Rating	Unit
Operating Case Temperature	-40 to +85	°C
Storage Temperature	-55 to +155	°C
Junction Temperature	+220	°C
Operating Voltage	+6.5	V
Supply Current	150	mA
Input RF Power	23	dBm

Operation of this device above any of these parameters may result in permanent damage.

### Typical Performances @45MHz - 800MHz

Typical conditions are at  $V_c = 5V$ ,  $T = 25^\circ C$ ,  $Z_L = 75\Omega$ , unless otherwise noted.

**S-parameters vs. Temp**

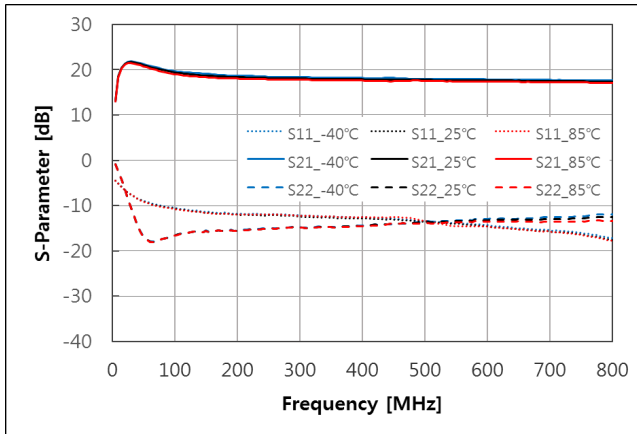

**Noise Figure vs. Frequency**

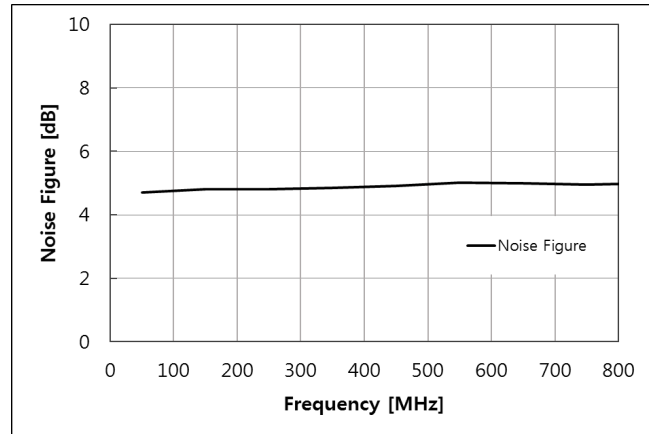

**OIP3 vs. Frequency**  
2dBm / Tone, 1MHz Spacing

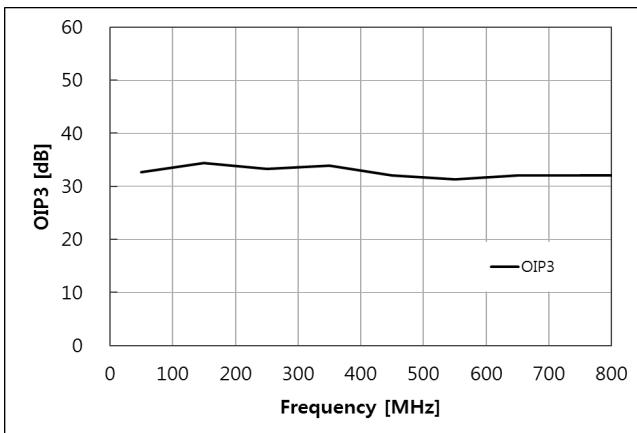

**P1dB vs. Frequency**

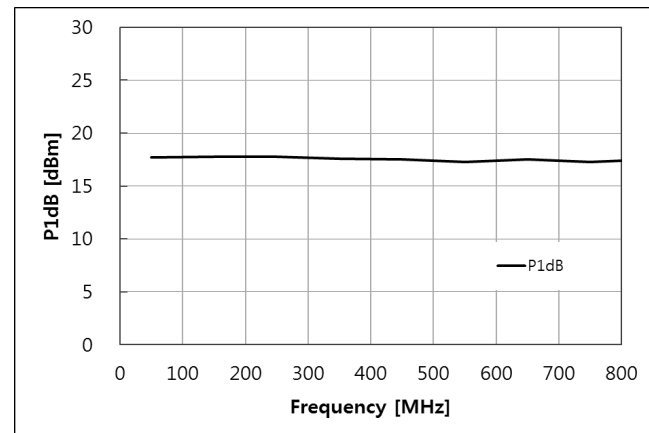

### Typical Performances @800MHz - 2200MHz

Typical conditions are at  $V_c = 5V$ ,  $T = 25^\circ C$ ,  $Z_L = 75\Omega$ , unless otherwise noted.

**S-parameters vs. Temp**

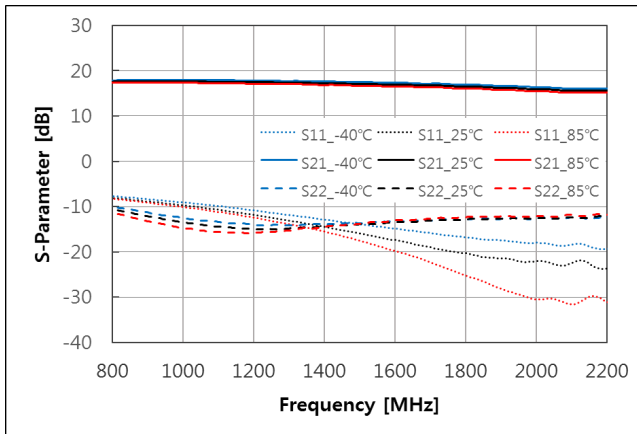

**Noise Figure vs. Frequency**

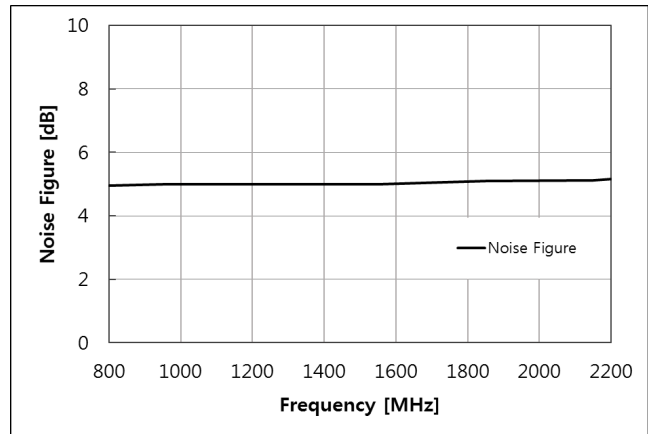

**OIP3 vs. Frequency**  
2dBm / Tone, 1MHz Spacing

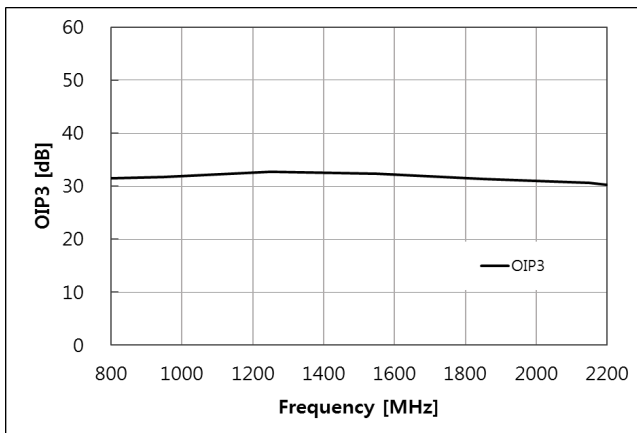

**P1dB vs. Frequency**

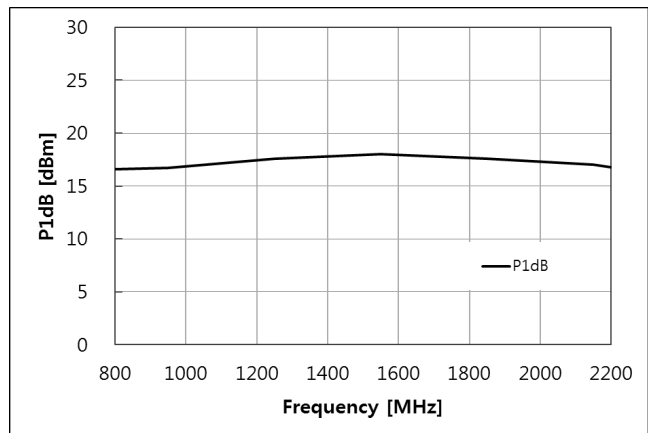

### Suggested PCB Land Pattern and PAD Layout

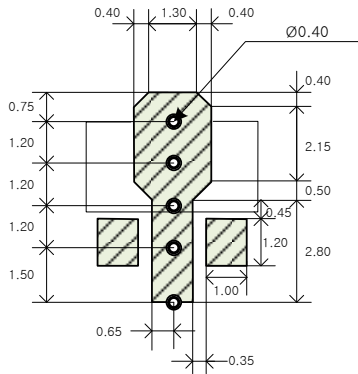
**PCB Land Pattern**

Note : All dimension \_ millimeters

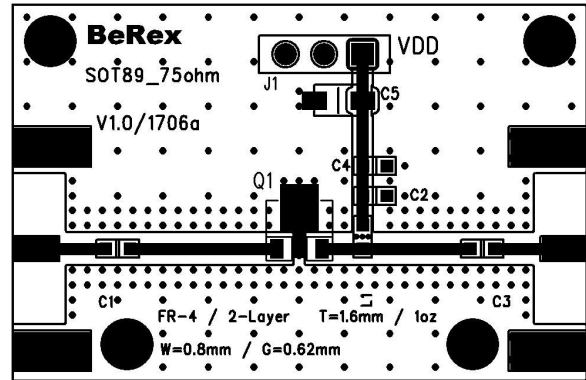
**PCB Mounting**

Note : PCB lay out \_ on BeRex website

### Applications Circuit and Bill of Material

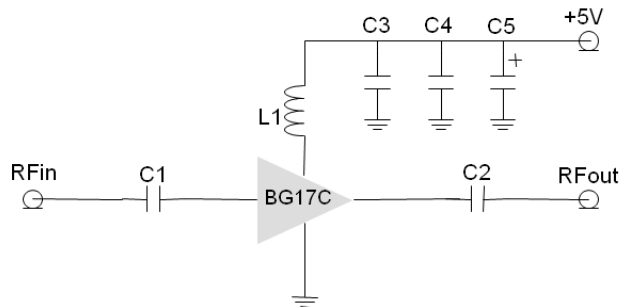
**Applications Circuit**

**Bill of Material**

No	Ref Des	Qty	Part Number	Remark
1	C1,C2	1	CAP 1608 100pF	800 to 2200MHz
		1	CAP 1608 1nF	45 to 800MHz
2	C3	1	CAP 1608 100pF	
3	C4	1	CAP 1608 1uF	
4	C5	1	CAP A type Tantal 10uF	
5	L1	1	IND 1608 33nH	800 to 2200MHz
		1	IND 1608 560nH	45 to 800MHz
6	J1	1	3 Pin Header	
7	RF in, RF out	2	F Type_END_LAUNCH	
8	Q1	1	BG17C	SOT-89

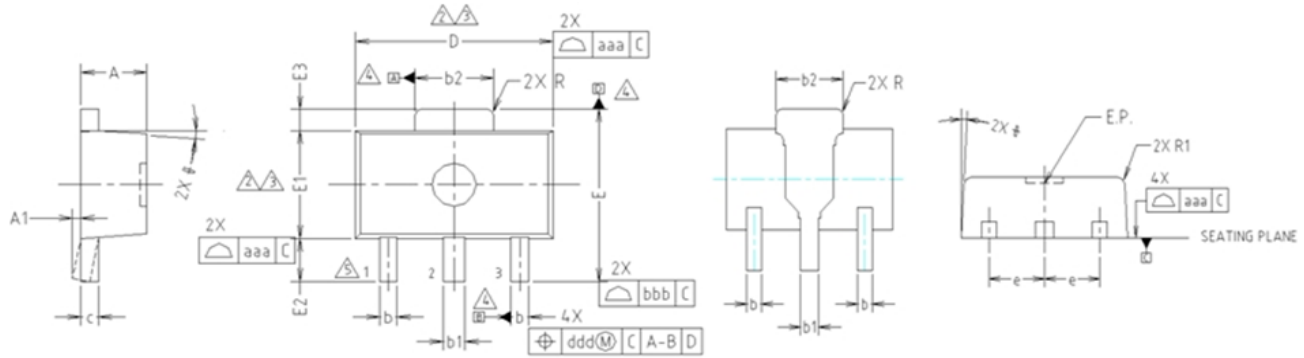
### Package Outline Dimension



NOTE:  
1. DIMENSIONS IN MILLIMETERS.

**△** DIMENSION D DOES NOT INCLUDE MOLD FLASH, PROTRUSIONS OR GATE BURRS. MOLD FLASH, PROTRUSIONS OR GATE BURRS SHALL NOT EXCEED 0.5mm PER END. DIMENSION E1 DOES NOT INCLUDE INTERLEAD FLASH OR PROTRUSION. INTERLEAD FLASH OR PROTRUSION SHALL NOT EXCEED 0.5mm PER SIDE.

**△** DIMENSIONS D AND E1 ARE DETERMINED AT THE OUTMOST EXTREMES OF THE PLASTIC BODY EXCLUSIVE OF MOLD FLASH, TIE BAR BURRS, GATE BURRS AND INTERLEAD FLASH, BUT INCLUDING ANY MISMATCH BETWEEN THE TOP AND BOTTOM OF THE PLASTIC BODY.

**△** DATUMS A, B AND D TO BE DETERMINED 0.18mm FROM THE LEAD TIP.

**△** TERMINAL NUMBERS ARE SHOWN FOR REFERENCE ONLY.

SYMBOL	MILLIMETERS			NOTE
	MINIMUM	NOMINAL	MAXIMUM	
A	1.40	1.50	1.60	
A1	0.00	—	0.10	
b	0.38	0.42	0.48	
b1	0.48	0.52	0.58	
b2	1.79	1.82	1.87	
c	0.40	0.42	0.46	
D	4.40	4.50	4.70	2,3
E	3.70	4.00	4.30	
E1	2.40	2.50	2.70	2,3
E2	0.80	1.00	1.20	
E3	0.40	0.50	0.60	
e	1.50 TYP.			
φ	4° TYP.			
R	0.15 TYP.			
R1	—	—	0.20	
SYMBOL	TEOLERANCES OF FORM AND POSITION	NOTE		
aaa	0.15			
bbb	0.20			
ccc	0.10			
ddd	0.10			

### Package Marking

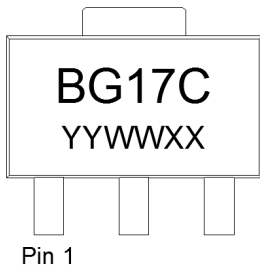

YY = Year, WW = Working Week,  
XX = Wafer No.

### Tape & Reel

SOT89

Packaging information:

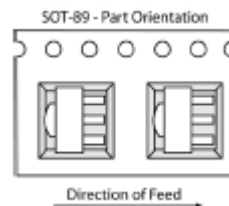

Tape Width (mm): 12  
Reel Size (inches): 7  
Device Cavity Pitch (mm): 8  
Devices Per Reel: 1000

## Lead plating finish

100% Tin Matte finish

(All BeRex products undergoes a 1 hour, 150 degree C, Anneal bake to eliminate thin whisker growth concerns.)

## MSL / ESD Rating

<b>ESD Rating:</b>	Class 2
<b>Value:</b>	Passes <4000V
<b>Test:</b>	Human Body Model (HBM)
<b>Standard:</b>	JEDEC Standard JESD22-A114B
<b>MSL Rating:</b>	<b>Level 1 at +265°C convection reflow</b>
<b>Standard:</b>	JEDEC Standard J-STD-020



Proper ESD procedures should be followed when handling this device.

## NATO CAGE code:

2	N	9	6	F
---	---	---	---	---